

**DESCRIPTION**

- Use with 30" or 36" deep Ultra Surfaces to construct height adjustable benches.
- The electrically driven self-guided aluminum assemblies have a 15" travel range from 26-1/2" to 41-1/2" to the underside of the surfaces, rising at 1/2" per second.
- Bases require 120 Volt, 60 Hz. power. A height control box with rocker switch and a 9-1/2' power cord are supplied.
- Amp draw: 4 Amps.
- Available with 4" polypropylene casters with totalock brakes (simultaneously locks the swivel and wheel).
- Gross dynamic load capacity 750 lbs. evenly distributed.
- Shipped fully assembled. Control boxes field installed to surfaces.
- This product is UL/CUL (US and Canada) recognized under UL962, File #E320513.

**PRODUCT DIMENSIONS**

Product Number	Description	Width in. [mm]	Depth in. [mm]	Weight lb. [kg]
ESERC72A	casters	66 [1676]	34-1/8 [867]	137 [62]

# ERGOSTAT® RISER FRAME

TABLES

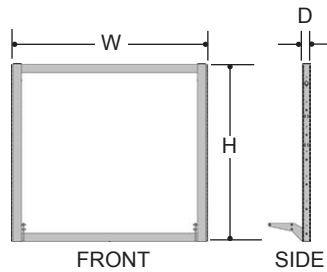
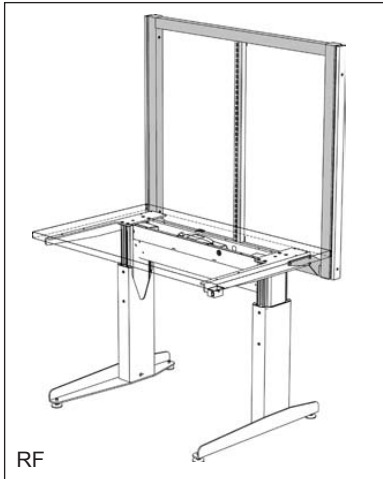

## DESCRIPTION

- Open style frame provides upright support for hanging components.
- Frame bolts to ErgoStat Base, adjusting in height with the base.
- Frame permits vertical adjustment of components in 1" increments and provides one attachment point for ESD grounding hardware per unit.
- Equipped with attachment points for Riser Spines; 36" wide Riser Frame excluded.
- Frame features 1/4"-20 threaded inserts for vertical inside mounting of Plug Strips. Riser Frames accommodate a 36" component per side.
- Load capacity 250 lbs.

## NOTES

- Riser Frames extend 38-1/2" above surfaces.
- Do not hang components from the unsupported side of a frame or panel.

## PRODUCT DIMENSIONS

Product Number	Height in. [mm]	Width in. [mm]	Depth in. [mm]	Weight lb. [kg]
RF4372	43 [1092]	72 [1829]	2 [51]	68 [31]

TABLES



# ERGOSTAT® RISER SPINES AND RISER FRAME END COVER

TABLES

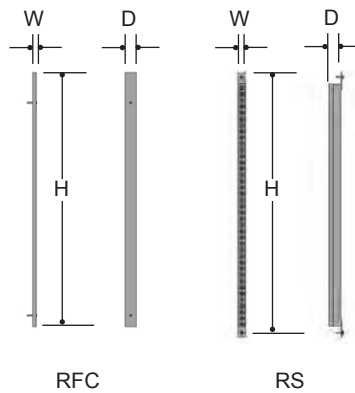
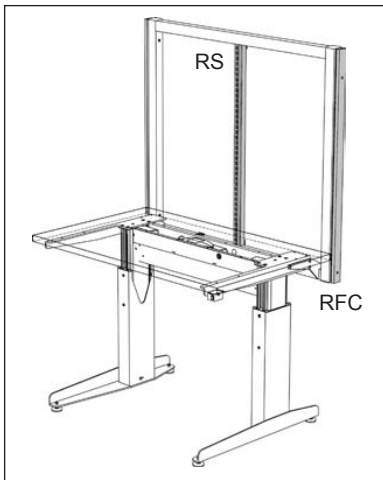

## DESCRIPTION

### Riser Spines

- Riser Spines divide ErgoStat Riser Frames into smaller sections and provide upright support for hanging components.
- Spines permit vertical adjustment of components in 1" increments and bolt to attachment points on Riser Frames.
- Riser Spines provide hanger frames on the front only; spines cannot be used for mounting Center Shelves or saddle-mounted arms.
- Finish is Black.

### Riser Frame End Covers

- Metal covers finish exposed hardware on the ends of Riser Frames.

## PRODUCT DIMENSIONS

Product Number	Description	Height in. [mm]	Width in. [mm]	Depth in. [mm]	Weight lb. [kg]
RS43BK	spine	43 [1092]	1-1/4 [32]	2 [51]	5 [2]
RFC43	end cover	43 [1092]	2 [51]	1/2 [13]	1 [.5]

TABLES

# CANTILEVER LIGHT BRACKETS

ELECTRICAL & AIR

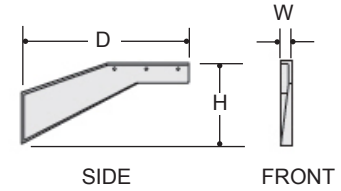
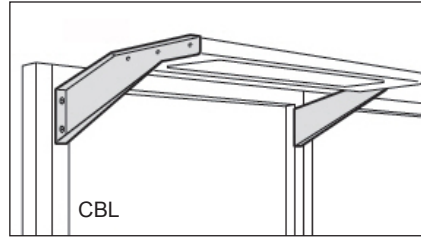
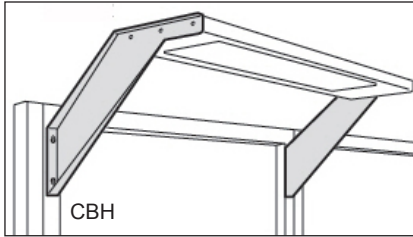

## DESCRIPTION

- Brackets provide overhead frame-mounted support for High Performance Task Lights and Overhead Tool Travelers.
- Low profile brackets mount flush with the top of frames when mounted in their highest position.
- High profile brackets extend 7-1/2" above frames when mounted in their highest position.

## NOTES

- Sold in pairs.
- Cantilever Light Brackets allow lights to span between two adjacent frames that are connected by a Panel Connector as well as mount to individual frames.

## PRODUCT DIMENSIONS

Product Number	Description	Height in. [mm]	Width in. [mm]	Depth in. [mm]	Weight lb. [kg]
CBL30	low profile extended, pair	7-1/2 [191]	2 [51]	30-1/2 [775]	10 [5]

ELECTRICAL & AIR



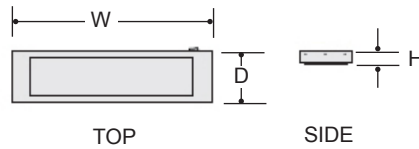
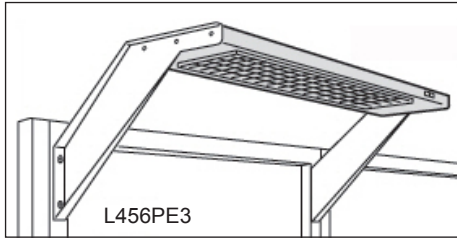

## DESCRIPTION

- Lights provide illumination for assembly tasks.
- Lights mount under shelves with Shelf Mount Light Brackets or to frames with Cantilever Light Brackets.
- Lights include premium triphosphorous cool white T8 lamps and a 9' cord with rear right-hand exit.
- Lights are available with batwing or glare reducing parabolic lenses and with two or four lamps.
- Four lamp fixtures each have a three-way switch allowing two or four lamps to be lit.

## PRODUCT DIMENSIONS

Product Number	Description	Height in. [mm]	Width in. [mm]	Depth in. [mm]	Weight lb. [kg]
L468PE3	four lamp, parabolic	2 [51]	68 [1727]	11 [279]	35 [16]

# MULTI-FUNCTION SHELVES

SHELVING

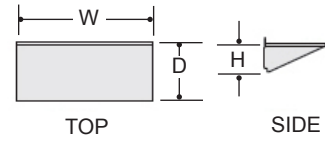
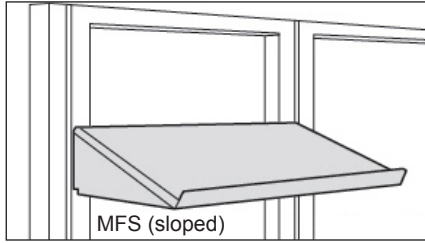
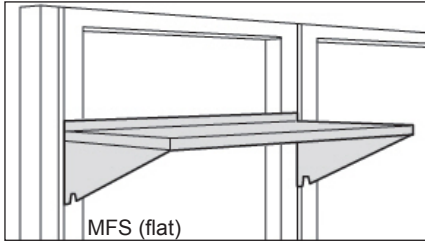

## DESCRIPTION

- Shelves provide general storage in workstations.
- Assemblies each include two steel support brackets and one shelf with a 1/2" raised edge that can be positioned in the front or back. No hardware or tools are needed for assembly.
- Shelves mount flat or in a sloped position.
- Load capacity 200 lbs. evenly distributed.

## NOTES

- Shelf Depth 15" Shelf Slope 17°
- When mounted on Fabric or Laminate Panels in the flat position, there is a 3/8" gap between the back of each shelf and the Panel limiting the amount of space for cord drops.
- Greenlee Manual Round Knockout Punches can be purchased for field installation of shelf grommets. Contact them at [www.greenlee.textron.com](http://www.greenlee.textron.com) for a distributor near you.

## PRODUCT DIMENSIONS

Product Number	Height in. [mm]	Width in. [mm]	Depth in. [mm]	Weight lb. [kg]
MFS1536	5-1/2 [140]	36 [914]	15 [381]	23 [10]

SHELVING



# ELECTRICAL PLUG STRIPS - 15 AMP

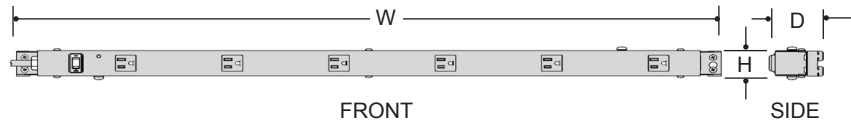
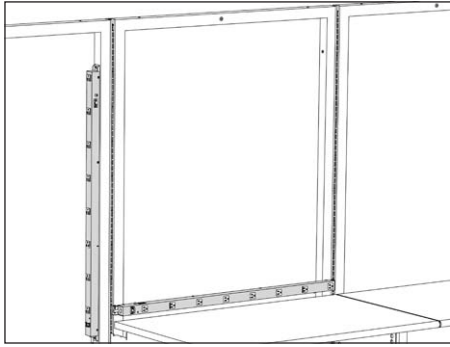

ELECTRICAL & AIR

## DESCRIPTION

- Plug Strips provide single circuit, 15 Amp, 110 Volt outlets where needed on frames.
- Each strip includes NEMA configuration 5-15R black simplex receptacles and a 5-15P plug.
- Strips mount horizontally to frames on hanger clips.
- Each strip includes a lighted, rocker-actuated circuit breaker with a built-in safety guard and an 8' power cord.
- One threaded insert located on each end of the Plug Strip allows for the grounding of dissipative workstation components.
- 15 Amp Plug Strips are UL listed.

## NOTES

- Power cords exit the end of each strip where the switch is located.



## PRODUCT DIMENSIONS

Product Number	Description	Height in. [mm]	Width in. [mm]	Depth in. [mm]	Weight lb. [kg]
EPS36	6 outlets	2 [51]	36 [914]	2 [51]	5 [2]

ELECTRICAL & AIR



# ELECTRIC BASE HAND CONTROL

TABLES



## DESCRIPTION

- Switches feature memory settings, digital feedback display and/or various mounting options.
- Finish is Black.
- This product is UL/CUL (US and Canada) recognized under UL962, File #E320513.

## NOTES

- Switches have extended lead time.

## PRODUCT DIMENSIONS

Product Number	Description	Weight lb. [kg]
DPF1C	rocker switch, 3 memory settings, digital display, bracket mount	1 [0.53]

TABLES

